



Cover 1:  
Demetra Tan Leather

Cover 2:  
Crinkle Taupe

Antique Feet

# Santorini Collection

foamflex™  
Award Winning Seating Technology

Colours represented are to be used as a guide only.  
Please refer to manufacturers swatch for a more accurate colour match.

Please note that colour shadings can vary slightly from each roll of fabric.  
We cannot guarantee a precise match to these samples or between cut lengths and upholstered goods.

06/05/2021



# SANTORINI COVER GUIDE: STANDARD BACK ONLY

Please use this guide when ordering the following pieces to clarify cover options.

Corner Group: LH2, COR, RH2 (L2, CO, R2)

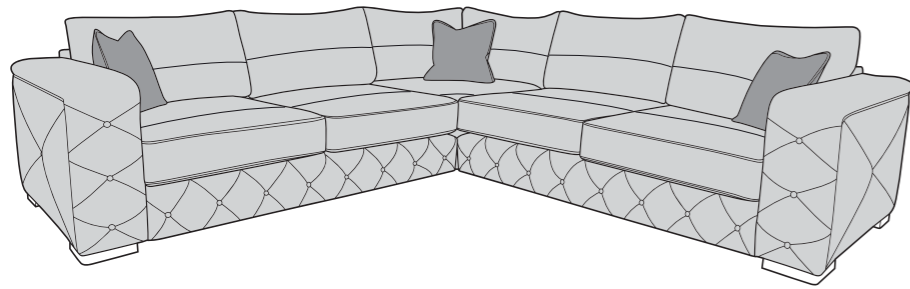

Corner Group: LH2, COR, RH1 (L2, CO, R1)

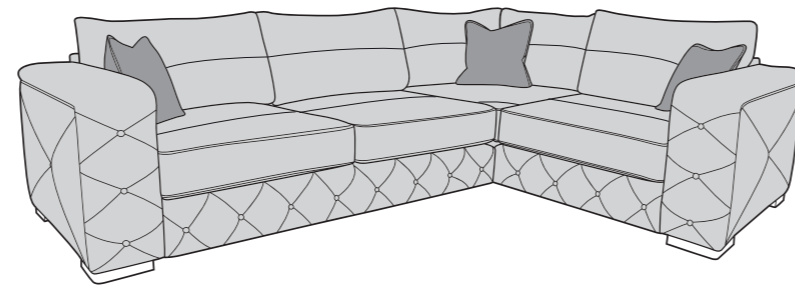

Corner Group: LH1, COR, RH2 (L1, CO, R2)

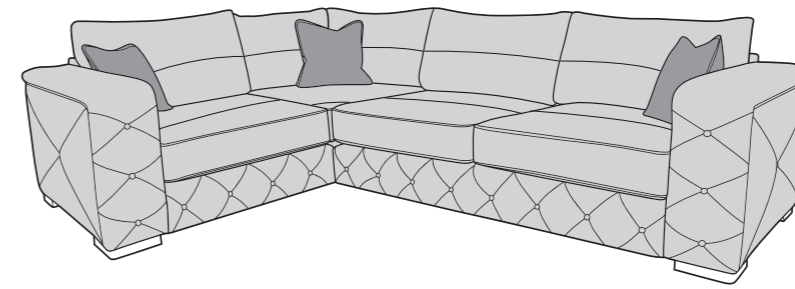

Corner Group: LH1, COR, RH1 (L1, CO, R1)

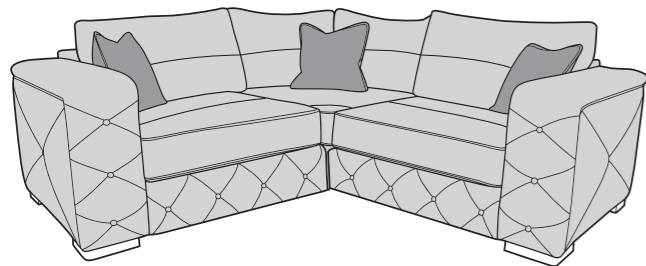

4 Seater Modular Sofa

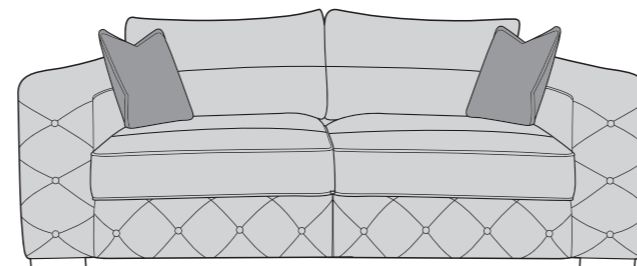

3 Seater Sofa (3ST)

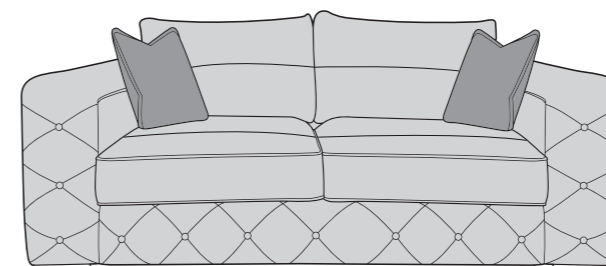

2 Seater Sofa (2ST)

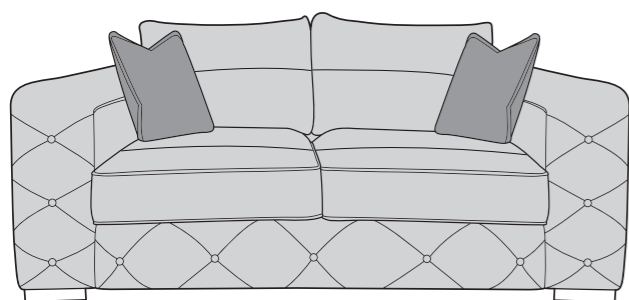

Love Chair (LOV)

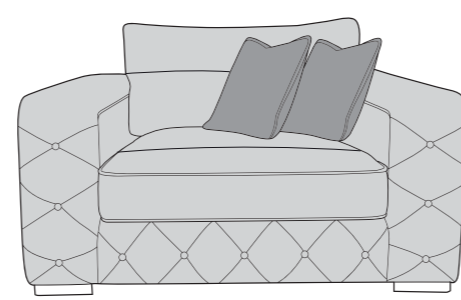

Arm Chair (1ST)

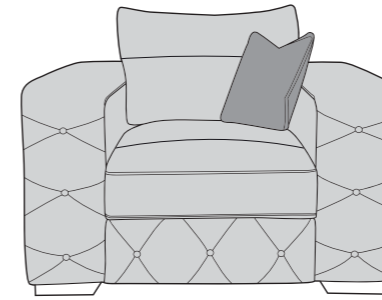

 **COVER 1**  
(BODY)

 **COVER 2**  
(FABRIC  
SCATTER)

## Scatter Cushions

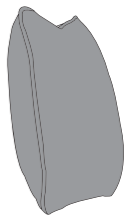

Flanged Edge  
Front = Cover 2  
Back = Cover 2

## ACCENT PIECES

Santorini  
Large Footstool (FST)

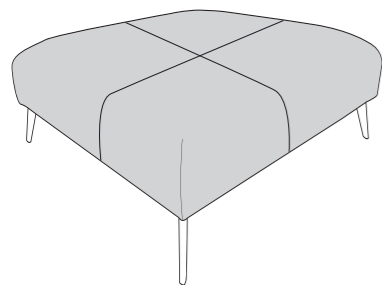

# SANTORINI DIMENSIONS (CM)

AVAILABLE PIECES	HEIGHT 1	OUTBACK HEIGHT	WIDTH 2	DEPTH 3	ARM HEIGHT	SEAT HEIGHT 4	SEAT DEPTH 5	SEAT WIDTH 6	ACCESS DIAGONAL 7	WEIGHT (KG)	SCATTER CUSHION NO.
LH2, COR, RH2 GROUP	81	67	277	277	64	44	67	N/A	N/A	145	3
LH1, COR, RH2 GROUP or LH1, COR, RH2 GROUP	81	67	277	203	64	44	67	N/A	N/A	127.5	3
LH1, COR, RH1 GROUP	81	67	203	203	64	44	67	N/A	N/A	110	3
LH2/RH2 UNIT	81	67	178	99	64	44	67	157	202	56	1
LH1/RH1 UNIT	81	67	104	99	64	44	67	N/A	N/A	38.5	1
COR - CORNER UNIT	81	67	99	99	N/A	44	67	N/A	139	33	1
<b>ACCENT PIECES</b>											
SANTORINI LARGE FOOTSTOOL (FST)	36	N/A	102	102	N/A	N/A	N/A	N/A	N/A	21.5	N/A
ZANDER LARGE FOOTSTOOL (FST)	36	N/A	102	102	N/A	N/A	N/A	N/A	N/A	21.5	N/A



\* Hardwood & composite board frame.

\* Dowelled, screwed, glued & stapled joinery.

\* Chrome & Wood foot options.

\* Fibre filled backs for added comfort.

\* Feather filled scatters included. 

\* Award winning foamflex seat interior with 5 year guarantee.

\* Serpentine seat springs & silent wire.

\* Elasticated back webbing.

## DIMENSION GUIDE

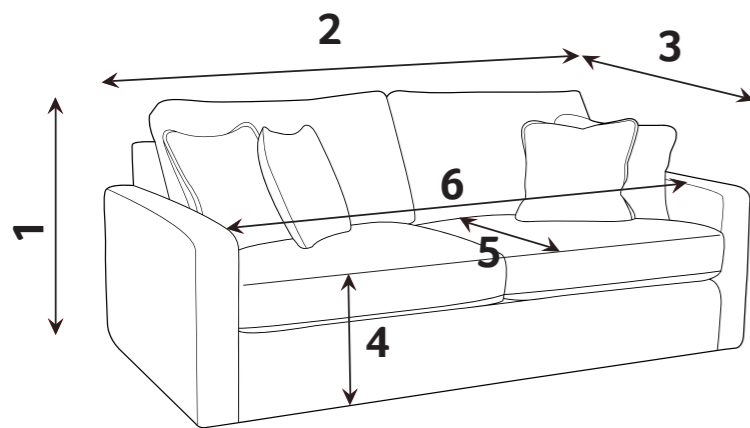

1 - HEIGHT  
2 - WIDTH

3 - DEPTH  
4 - SEAT HEIGHT

5 - SEAT DEPTH (STD & PILLOW)  
6 - SEAT WIDTH

7 - DIAGONAL ACCESS

Check the diagonal access dimension to ensure furniture will fit in your home.

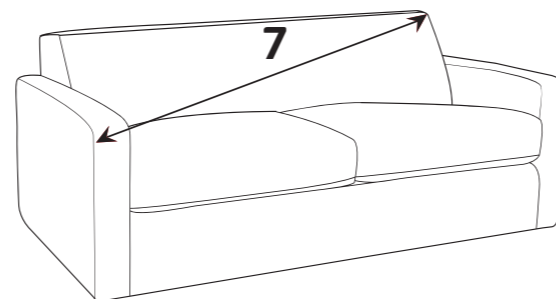

Illustrations used for reference only.

## foamflex

Our new expertly engineered foam seat interior gives you the comfort of fibre with the retention of foam.

## CARE GUIDE

To improve the longevity of your hand-made furniture, we recommend rotating cushions (where applicable).

For further information on maintaining your furniture, please refer to the Care Guide located under the seat platform.



Our foamflex seat interiors have been granted the FIRA GOLD Award, a mark of quality under-pinning all necessary testing of the product materials, design and production techniques.

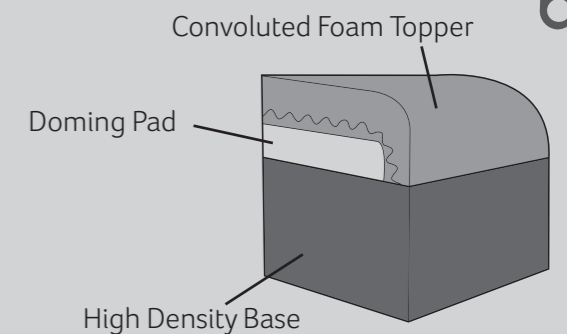

Chrome

Mid Oak

Antique

Footstool Feet:

Chrome

Mid Oak

Antique

FOOT OPTIONS:

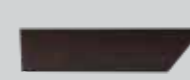

Please note : All dimension are approximate. Allow tolerance of +/- 2.5cm.



06/05/2021